

Pin Definition:

- | | |
|-----------|----------|
| 1. Source | 8. Drain |
| 2. Source | 7. Drain |
| 3. Source | 6. Drain |
| 4. Gate | 5. Drain |

Key Parameter Performance

Parameter	Value	Unit
V_{DS}	20	V
$R_{DS(on)}$ (max)	$V_{GS} = 4.5V$	20
	$V_{GS} = 2.5V$	25
	$V_{GS} = 1.8V$	31
Q_g	12.3	nC

Features

- Advanced High Cell Density Trench Technology.
- Low Gate Charge.

Application

- Networking DC-DC Power System.
- Load Switch.

Ordering Information

Part No.	Package	Packing
TSM4806CS RLG	SOP-8	2.5kpcs / 13" Reel

Note: "G" denotes Halogen Free Product.

Block Diagram

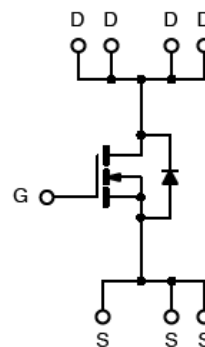

N-Channel MOSFET

Absolute Maximum Ratings ($T_A=25^{\circ}C$, unless otherwise noted)

Parameter	Symbol	Limit	Unit
Drain-Source Voltage	V_{DS}	20	V
Gate-Source Voltage	V_{GS}	± 8	V
Continuous Drain Current ^a	I_D	28	A
Pulsed Drain Current ^b	I_{DM}	70	A
Continuous Source Current (Diode Conduction) ^{a,c}	I_S	28	A
Total Power Dissipation	P_D	2	W
Storage Temperature Range	T_{STG}	-55 to +150	$^{\circ}C$
Operating Junction Temperature Range	T_J	-55 to +150	$^{\circ}C$

Thermal Performance

Parameter	Symbol	Limit	Unit
Thermal Resistance Junction to Lead	$R_{\theta_{JL}}$	40	$^{\circ}C/W$
Thermal Resistance Junction to Ambient	$R_{\theta_{JA}}$	62.5	$^{\circ}C/W$

Notes:

- a. The data tested by surface mounted on a 1 inch² FR-4 board with 2oz copper.
- b. The data tested by pulsed, pulse width $\leq 300\mu s$, duty cycle $\leq 2\%$ surface mounted on FR4 Board, $t \leq 5s$.
- c. The data is theoretically the same as I_D and I_{DM} , in real applications, should be limited by total power dissipation.

Electrical Specifications

Parameter	Conditions	Symbol	Min	Typ	Max	Unit
Static						
Drain-Source Breakdown Voltage	$V_{GS} = 0V, I_D = 250\mu A$	BV_{DSS}	20	--	--	V
Gate Threshold Voltage	$V_{DS} = V_{GS}, I_D = 250\mu A$	$V_{GS(TH)}$	0.3	0.6	1.0	V
Gate-Source Leakage Current	$V_{GS} = \pm 8V, V_{DS} = 0V$	I_{GSS}	--	--	± 100	nA
Drain-Source Leakage Current	$V_{DS} = 16V, V_{GS} = 0V$	I_{DSS}	--	--	1	μA
Drain-Source On-State Resistance	$V_{GS} = 4.5V, I_D = 20A$	$R_{DS(ON)}$	--	16	20	m Ω
	$V_{GS} = 2.5V, I_D = 15A$		--	20	25	
	$V_{GS} = 1.8V, I_D = 10A$		--	25	31	
Forward Transconductance	$V_{DS} = 5V, I_D = 15A$	g_{fs}	--	27	--	S
Diode Forward Voltage	$I_S = 1A, V_{GS} = 0V$	V_{SD}	--	--	1.2	V
Dynamic^b						
Gate Resistance	$V_{DS} = 0V, V_{GS} = 0V, f = 1MHz$	R_g	--	1.4	2.8	Ω
Total Gate Charge	$V_{DS} = 15V, I_D = 15A, V_{GS} = 4.5V$	Q_g	--	12.3	--	nC
Gate-Source Charge		Q_{gs}	--	1.95	--	
Gate-Drain Charge		Q_{gd}	--	3.08	--	
Input Capacitance	$V_{DS} = 15V, V_{GS} = 0V, f = 1MHz$	C_{iss}	--	961	--	pF
Output Capacitance		C_{oss}	--	92.3	--	
Reverse Transfer Capacitance		C_{rss}	--	80.4	--	
Reverse Recovery Time	$I_F = 15A, dI/dt = 100A/\mu s, T_J = 25^\circ C$	t_{rr}	--	6	--	ns
Reverse Recovery Charge		Q_{rr}	--	1.38	--	nC
Switching^{b,c}						
Turn-On Delay Time	$V_{DD} = 10V, I_D = 15A, V_{GS} = 4.5V, R_G = 3.3\Omega$	$t_{d(on)}$	--	3.02	--	ns
Turn-On Rise Time		t_r	--	13.1	--	
Turn-Off Delay Time		$t_{d(off)}$	--	28	--	
Turn-Off Fall Time		t_f	--	8.3	--	

Notes:

- Pulse test: $PW \leq 300\mu s$, duty cycle $\leq 2\%$
- For DESIGN AID ONLY, not subject to production testing.
- Switching time is essentially independent of operating temperature.

Electrical Characteristics Curve ($T_A=25^\circ\text{C}$, unless otherwise noted)

Output Characteristics

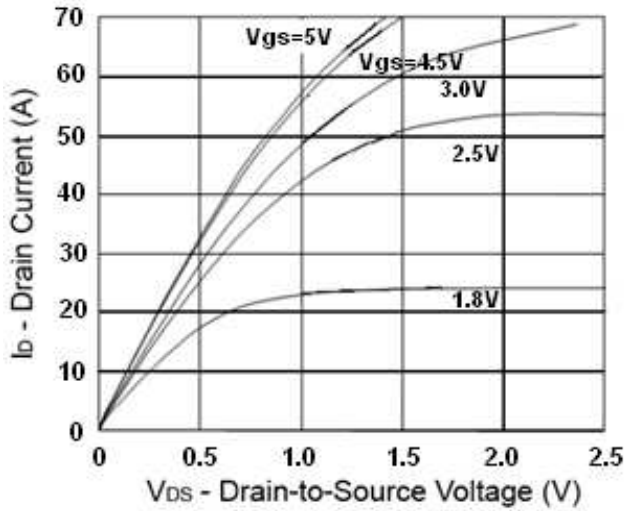

On-Resistance vs. Gate-Source Voltage

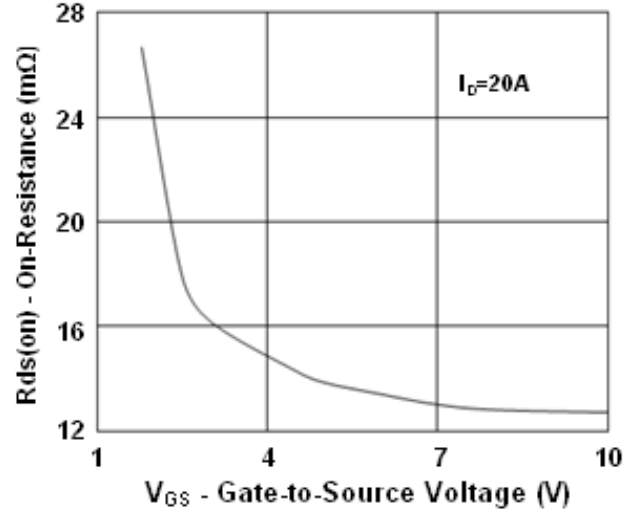

Source-Drain Diode Forward Voltage

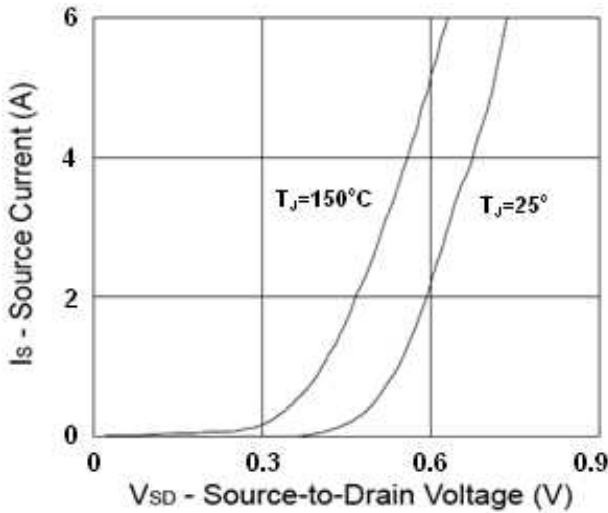

Gate Charge

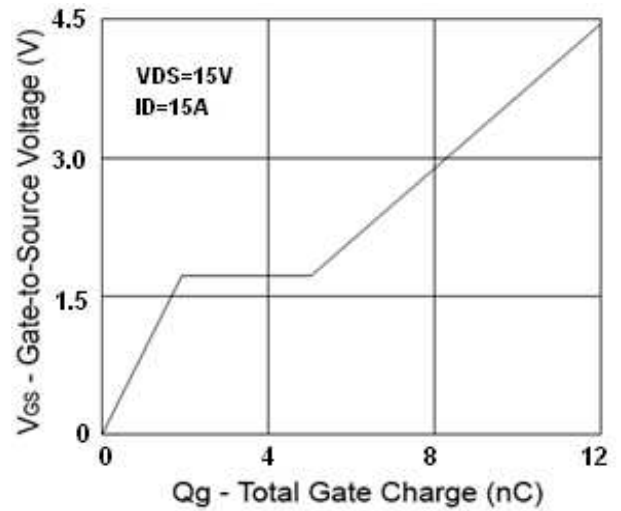

Normalized $V_{GS(th)}$ vs. T_J

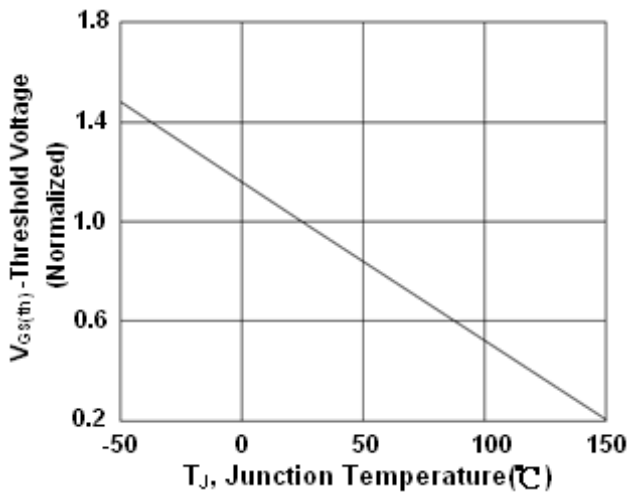

Normalized $R_{DS(on)}$ vs. T_J

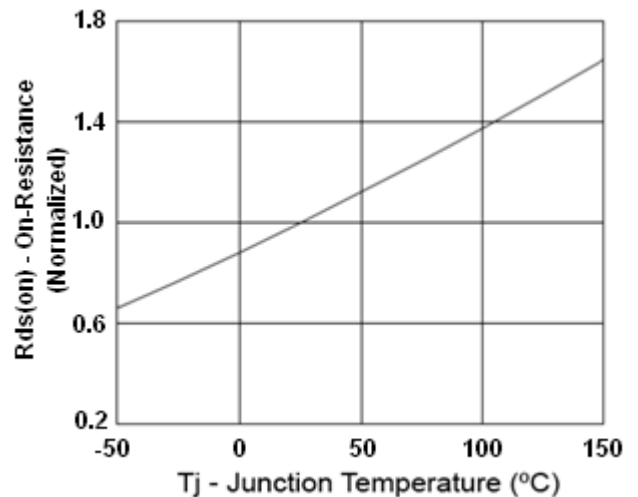

Electrical Characteristics Curve ($T_A=25^{\circ}\text{C}$, unless otherwise noted)

Capacitance

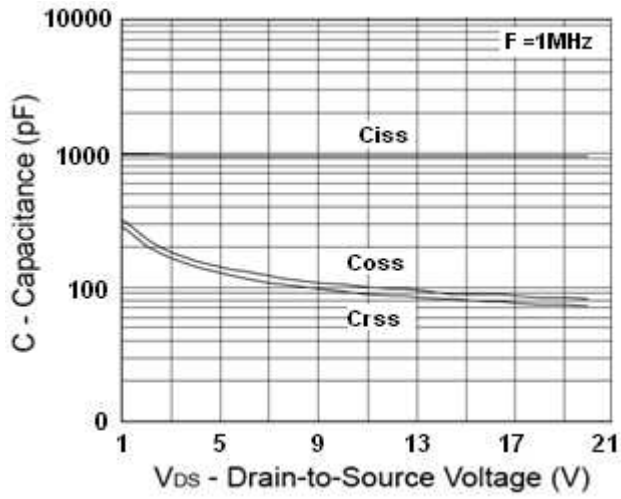

SOP-8 Mechanical Drawing

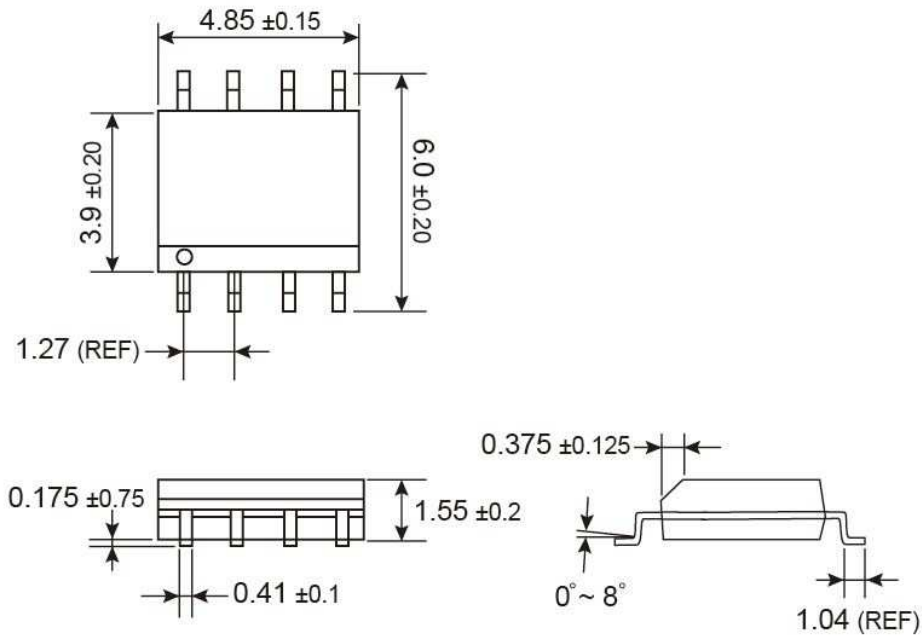

Unit: Millimeters

Marking Diagram

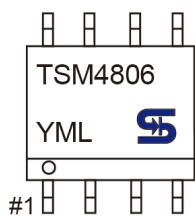

- Y** = Year Code
- M** = Month Code for Halogen Free Product
(**O**=Jan, **P**=Feb, **Q**=Mar, **R**=Apr, **S**=May, **T**=Jun, **U**=Jul, **V**=Aug, **W**=Sep, **X**=Oct, **Y**=Nov, **Z**=Dec)
- L** = Lot Code

Notice

Specifications of the products displayed herein are subject to change without notice. TSC or anyone on its behalf, assumes no responsibility or liability for any errors or inaccuracies.

Information contained herein is intended to provide a product description only. No license, express or implied, to any intellectual property rights is granted by this document. Except as provided in TSC's terms and conditions of sale for such products, TSC assumes no liability whatsoever, and disclaims any express or implied warranty, relating to sale and/or use of TSC products including liability or warranties relating to fitness for a particular purpose, merchantability, or infringement of any patent, copyright, or other intellectual property right.

The products shown herein are not designed for use in medical, life-saving, or life-sustaining applications. Customers using or selling these products for use in such applications do so at their own risk and agree to fully indemnify TSC for any damages resulting from such improper use or sale.